

Sauna control unit

just sauna fin

JUST-105D-FI / JUST-105W-FI

INSTRUCTIONS FOR INSTALLATION AND USE
English

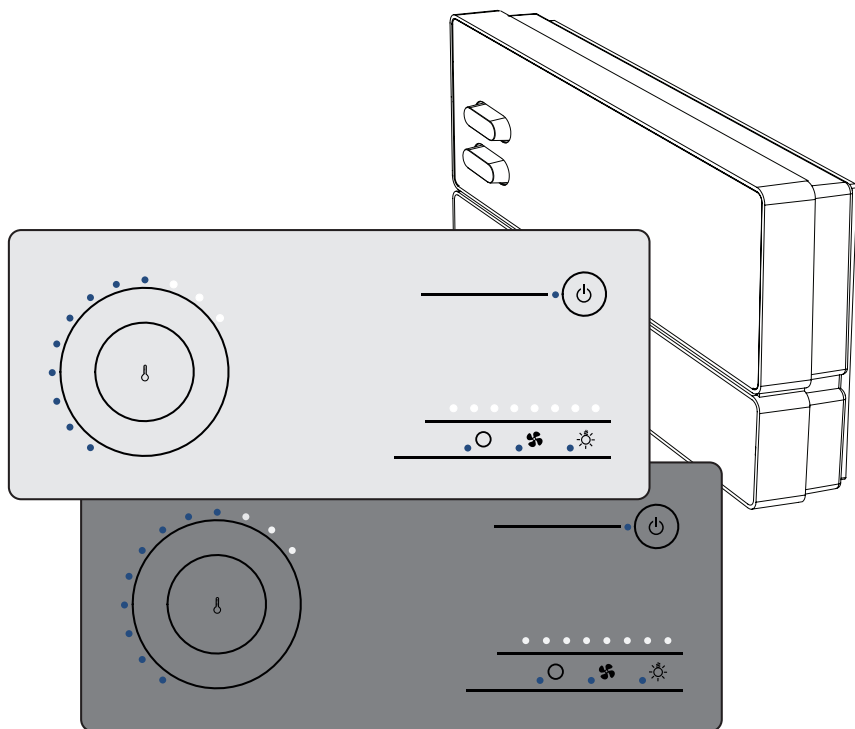

Table of Contents

1. About these instructions	5
2. Important information for your safety	6
2.1. Intended use	6
2.2. Safety information for the installer	6
2.3. Safety information for the user	7
3. Product description	9
3.1. Scope of delivery	9
3.2. Accessories	9
3.3. Product functions	9
3.4. Sensor operating modes	10
4. Installation	11
4.1. Installing the power unit	12
4.2. Installing the operating unit	13
4.3. Installing the heater sensor F1 with excess temperature fuse	14
4.4. Installing the bench sensor F2	15
4.5. Installing the foil sensor (optional)	16
5. Electrical connection	17
5.1. Connecting the power supply cable and heater cable	18
5.2. Connecting the operating unit	18
5.3. Connecting the light	18
5.4. Connecting the fan (optional)	19
5.5. Connecting the additional output (optional)	19
5.6. Connecting the power booster (optional)	19
5.7. Connecting heater sensor F1	20
5.8. Connecting bench sensor F2	20

5.9.	Connecting the foil sensor (optional).....	20
5.10.	Status output.....	20
5.11.	Finishing installation.....	20
6.	Performing tests	21
7.	Connection diagram	23
8.	Starting up	24
8.1.	Setting the fan operating mode.....	24
8.2.	Activating single-sensor mode.....	25
8.3.	Activating/deactivating phase alignment.....	25
8.4.	Setting the light operating mode.....	25
8.5.	Activating/deactivating the foil sensor.....	26
8.6.	Status output.....	26
8.7.	Setting the operating mode for the additional output.....	26
9.	Operating elements	27
9.1.	On the power unit.....	27
9.2.	On the operating unit.....	27
9.3.	The touch wheel.....	28
9.4.	Touch wheel scaling.....	28
9.5.	Power level display.....	29
10.	Operation	30
10.1.	Switching on the light on the power unit (cleaning lights).....	30
10.2.	Switching on the power unit.....	30
10.3.	Activating the operating unit.....	30
10.4.	Starting the sauna.....	31

10.5.	Switching off the sauna.....	31
10.6.	Switching on the additional output.....	31
10.7.	Switching off the additional device.....	32
10.8.	Switching on the light.....	33
10.9.	Switching off the light.....	33
10.10.	Switching on the fan.....	34
10.11.	Switching off the fan.....	34
10.12.	Deactivating the operating unit.....	35
10.13.	Switching off the power unit.....	35
11.	Cleaning and maintenance	36
11.1.	Cleaning.....	36
11.2.	Maintenance.....	36
12.	Disposal	36
13.	Troubleshooting	37
14.	Fuses	38
15.	Technical data	39

1. About these instructions

Read these installation and operating instructions carefully and keep them within reach when using the sauna control unit. This means you can refer to information regarding both your own safety and sauna operation at any time.



These installation and operating instructions can also be found in the downloads section of our website: www.sentiotec.com/downloads.

Symbols used for warnings

These installation and operating instructions feature warning symbols next to activities that present a hazard to the user. Warning symbols must be observed at all times. This prevents damage to property and injuries which could, in the worst case, be fatal.

The warning symbols contain keywords that mean the following:



DANGER!

Serious or fatal injury will occur if this warning symbol is not observed.



WARNING!

Serious or fatal injury can occur if this warning symbol is not observed.



CAUTION!

Minor injuries can occur if this warning symbol is not observed.

ATTENTION!

This keyword is a warning that damage to property may occur.

Other symbols



This symbol indicates tips and useful information.

2. Important information for your safety

The sauna control unit just sauna fin has been produced in accordance with the applicable safety regulations for technical units. However, hazards may still occur during use. You should therefore adhere to the following safety information and the specific warnings in the individual chapters. Also observe the safety information for the devices connected.

2.1. Intended use

The sauna control unit just sauna fin is used exclusively for operating and controlling sauna heaters, lighting units and ventilators in a private household in accordance with the technical data.

The sauna control unit just sauna fin is only suitable for installation outside the sauna room.

Any use exceeding this scope is considered improper. Improper use can result in damage to the product, severe injuries or death.

2.2. Safety information for the installer

- Installation may only be performed by a qualified electrician or similarly qualified person.
- Work on the sauna control unit may only be performed when the power has been disconnected.
- An all-pole disconnecting device with full cut-off compliant with overvoltage category III must be fitted on-site.

- The sauna control unit must be installed outside the sauna cabin at a height of approx. 1.70 m, or in accordance with the recommendation given by the sauna manufacturer. The ambient temperature must be within a range spanning -10 °C to +40 °C.
- The heater sensor must be attached in a way that ensures it is not affected by inflow of air.
- The heater supply cable must have a minimum cross-section of 2.5 mm² and be temperature resistant up to 150 °C.
- Observe all regulations applicable at the installation location.
- For your own safety, consult your supplier in the event of problems that are not explained in sufficient detail in the installation instructions.

2.3. Safety information for the user

- The just sauna fin control unit must not be used by children under 8 years of age.
- The just sauna fin control unit may only be used by children above 8 years of age, by persons with limited psychological, sensory or mental capabilities or by persons with lack of experience/knowledge under the following conditions:
 - When they are supervised.
 - When they have been shown how to use the device safely and are aware of the hazards that could occur.

- Children must not play with the sauna control unit.
- Children under 14 years of age may only clean, or perform maintenance on, the sauna control unit if they are supervised.
- For health reasons, do not use the sauna when under the influence of alcohol, medication or drugs.
- Make sure that no flammable objects have been placed on the sauna heater before the sauna control unit is switched on.
- Make sure that no flammable objects have been placed on or in front of the infrared lamp before the sauna control unit is switched on.
- For your own safety, consult your supplier in the event of problems that are not described in sufficient detail in the operating instructions.

3. Product description

3.1. Scope of delivery

- Operating unit
- Power unit
- Heater sensor with integrated excess temperature fuse (F1)
- Bench sensor (F2)
- Sensor wires
- Installation material

3.2. Accessories

- Foil sensor (item number: P-ISF-FF)
- Power booster (item number: O-S2-18 / O-S2-30)
- Safety shut-off (item number: HT-SWL)

3.3. Product functions

The sauna control unit just sauna fin features the following functions:

- Regulation of sauna heaters of up to 10.5 kW in the temperature range spanning 55 °C to 110 °C.
- A power booster allows the maximum heating output to be increased from 10.5 kW to 18 kW or 30 kW.
- Optional dimming or activation of a room light (up to 100 W)
- Optional dimming or activation of a fan (up to 100 W)
- Optional dimming (up to 500 W) or activation (up to 3.5 kW) for an additional output.

The additional output does not feature an excess temperature fuse. For this reason, only intrinsically safe devices should be operated using the additional output.

- If infrared lamps are connected to the additional output, these must have an excess temperature fuse. We recommend using the following infrared lamps:
 - DIR-350-R, WIR-350-R, DIR-500-R, WIR-500-R, DIR-750-R, WIR-750-R, DIR-1300-R, WIR-1300-R
 - ECO-350-R, ECO-350-G, ECO-500-R, ECO-500-G, ECO-750-R

- If one of the following infrared heat plates is connected to an additional output, the foil sensor P-ISX-FF must be used, and must be activated when first starting operation (see **8.5. Activating/deactivating the foil sensor** on page **26**):
 - IR-WP-100, IR-WP-175, IR-WP-390, IR-WP-510
 - IR-WPHL-100, IR-WPHL-175, IR-WPHL-390, IR-WPHL-510
- Automatic heating period limiter
If the operating unit has been running continuously for 6 hours, the sauna control unit switches off all the consumers for safety reasons. The operating unit switches to standby mode.
- Status output
- Excess temperature fuse
The excess temperature fuse is installed in the housing for the heater sensor. Should the sauna heater continue heating after reaching the preferred temperature due to a defect, the excess temperature fuse switches the sauna heater off at a temperature of approx. 139 °C.

3.4. Sensor operating modes

The sauna control unit can be operated with one or two temperature sensors.

Single sensor mode (F1)

Single-sensor mode must be activated when starting up the sauna for the first time (see **8.2. Activating single-sensor mode** on page **25**).

In single-sensor mode, the sauna control unit is operated with the heater sensor with an excess temperature fuse (F1) only. In single-sensor mode, the sauna control unit only displays the set temperature. The actual temperature is not displayed.

Two-sensor mode with bench sensor (F2)

The second temperature sensor is installed above the rear sauna bench (bench sensor). In two-sensor mode, the sauna control unit displays the temperature measured by the bench sensor as the actual temperature.

4. Installation

ATTENTION!

Damage to the unit

The sauna control unit is protected against jets of water, however direct contact with water could still damage the unit.

- Install the sauna control unit in a dry place at which a maximum humidity of 95% is not exceeded.
-

ATTENTION!

Sources of interference can have a negative effect on signal transmission

- Lay all sensor wires separately from other mains wires and control wires.
 - Protect wires with only one layer of insulation by using a pipe (double insulation).
-

Observe the following points when installing the sauna control unit:

- The power unit and the operating unit must be installed outside the sauna room or in accordance with the recommendation issued by the sauna manufacturer.
- The ambient temperature must be within a range spanning -10 °C to +40 °C.
- The sensors may only be connected using the sensor wires provided with the unit, which are heat-resistant up to 150 °C.



The sensor wires may be extended under the following conditions:

- When a silicone cable resistant to temperatures up to 150 °C is used.
 - The minimum cross-section of the wire totals 0.5 mm².
 - The length of the heater sensor wires may NOT exceed 10 m.
-

4.1. Installing the power unit

1. Screw two cross-head screws (16 mm) into the wall of the sauna at a height of approx. 1.70 m to a distance of up to 7 mm. The two screws must be placed at a distance of 145 mm from each other (see **Fig. 1**).

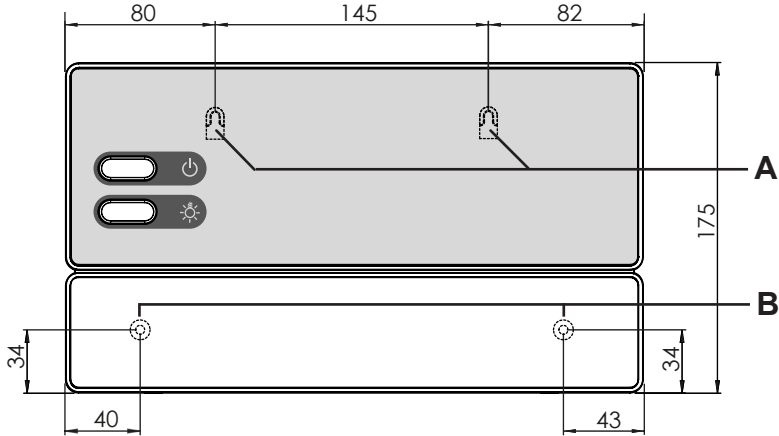

Fig. 1 Position of the attachment device and the installation holes (dimensions in mm)

2. Press the clip locks **C** in lightly using a screwdriver and remove the cover from the housing (see **Fig. 2**).
3. Fasten the sauna control unit onto the cross-head screws using the attachment device **A** as an aid (see **Fig. 1**).
4. Screw two cross-head screws (16 mm) into the lower fastening holes **B** (see **Fig. 1**).

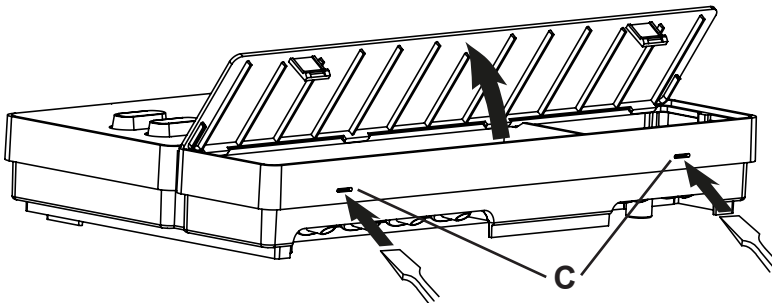



Fig. 2 Removing the cover from the housing

4.2. Installing the operating unit

 The installation frame can be affixed using the fixing plates **D** on walls up to 18 mm thick. If the wall is thicker, the installation frame must be affixed using screws which are screwed into the fastening holes **B**.

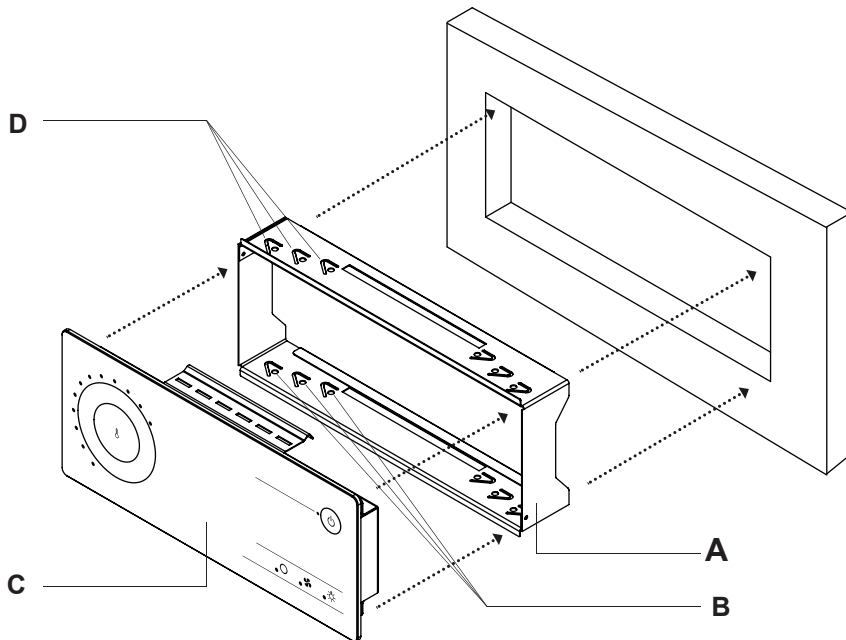

Fig. 3 Installing the operating unit

A Installation frame

B Fastening holes

C Operating unit

D Fixing plates

EN

To install the operating unit, perform the following steps:

1. Prepare the installation cut-out (213 x 82 mm) in the wall of the sauna.
2. Place the installation frame **A** into the installation cut-out.
3. Affix the installation frame by bending the fixing plates **D** outwards using a screwdriver.
4. Lay the RJ-12 cable in the wall of the sauna room, leading it from the power unit installation location to the installation cut-out for the operating unit.
5. Connect the plug of the RJ-12 cable to the connection socket on the rear of the operating unit.
6. Place the operating unit **C** into the installation frame **A**.

4.3. Installing the heater sensor F1 with excess temperature fuse

Observe the following points when installing the heater sensor:

- The heater sensor must be installed on the rear of the heater, above the middle of the sauna heater. A distance of approx. 15 cm to the roof of the sauna cabin must be maintained.
- The heater sensor must be attached in a way that ensures it is not affected by inflow of air.

To install the heater sensor, perform the following steps (see **Fig. 4**):

1. Lay the two 2-pin heater sensor wires in the wall of the sauna room, leading them to the heater sensor installation location and affix the heater sensor wires using wire clips.
2. Pull the two half-shells **1** of the heater sensor apart.
3. Connect the four connectors for the heater sensor wire **5** in accordance with the **Fig. 4**.
4. Place the connection panel **2** crossways (as shown in **Fig. 4**) in the heater sensor half-shells.

5. Place the two half-shells together, screw them together using the two cross-head screws **3** (9 mm) and check whether the heater sensor has been securely closed.
6. Install the heater sensor on the rear of the heater using the two wood screws enclosed **6** (16 mm).

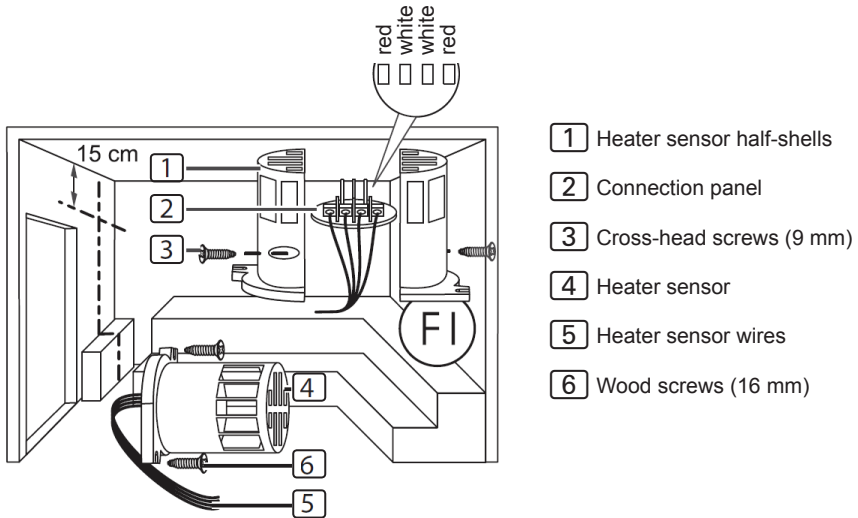

Fig. 4 Installing the heater sensor (F1)

4.4. Installing the bench sensor F2

The bench sensor must be installed on the wall of the sauna room, above the rear bench seat. A distance of approx. 15 cm to the roof of the sauna cabin must be maintained.

To install the bench sensor, perform the following steps:

1. Lay the two 2-pin bench sensor wires in the wall of the sauna room, leading them to the bench sensor installation location and affix the bench sensor wires using wire clips.

2. Pull the two half-shells of the bench sensor apart.
3. Connect the two connectors for the bench sensor wire to the two middle terminals on the connection panel.
4. Place the connection panel crossways in the bench sensor half-shells.
5. Place the two half-shells together and screw them together using the two cross-head screws (9 mm).
6. Check whether the bench sensor has been securely closed.
7. Install the bench sensor on the wall of the sauna room using the two wood screws enclosed (16 mm). Maintain a gap of 15 cm to the roof of the sauna room.

4.5. Installing the foil sensor (optional)

If one of the following infrared heat plates is connected to an additional output, the foil sensor P-ISX-FF must be used:

- IR-WP-100
 - IR-WP-175
 - IR-WP-390
 - IR-WP-510
 - IR-WPHL-100
 - IR-WPHL-175
 - IR-WPHL-390
 - IR-WPHL-510
- When installing the foil sensor, observe the operating instructions for the infrared heat plates.
 - The foil sensor must be activated when starting up the sauna for the first time (see **8.5. Activating/deactivating the foil sensor** on page **26**).

5. Electrical connection

ATTENTION!

Damage to the unit

- The sauna control unit may only be used for operating and regulating 3 heating circuits with a maximum heating capacity of 3.5 kW per heating circuit. The maximum additional output capacity totals 3.5 kW.

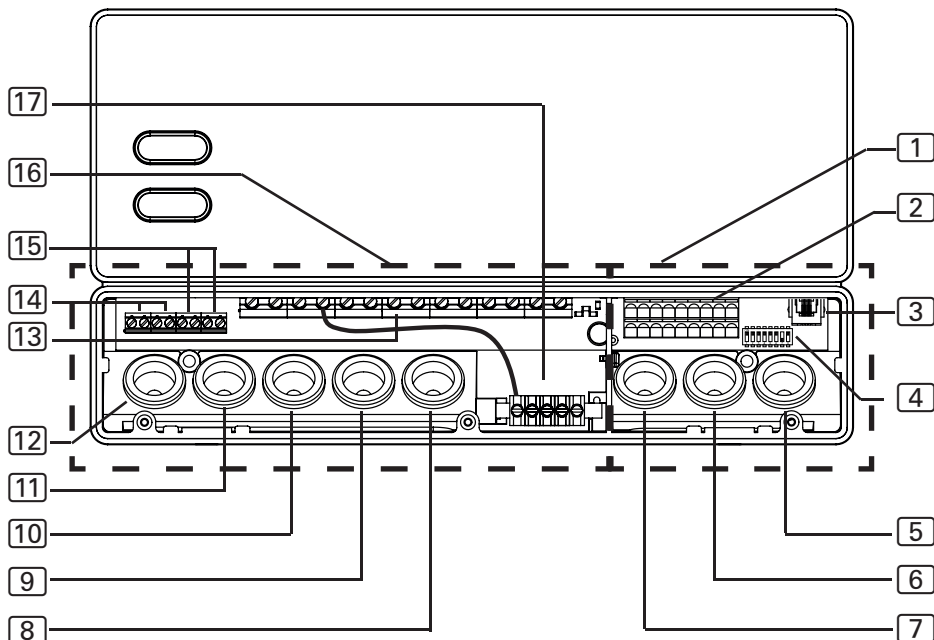

- | | |
|--|---|
| 1 Low-voltage connection area | 8 Cable bushing for additional output |
| 2 Terminal strips for safety shut-off device, status output and sensor wires | 9 Cable bushing for heater wire |
| 3 Connection socket for operating unit | 10 Cable bushing for power supply cable |
| 4 Function selection switch | 11 Cable bushing for power booster |
| 5 Cable bushing for operating unit, F2 and foil sensors | 12 Cable bushing for lights and fan |
| 6 Cable bushing for F1 sensor and status output | 13 Terminal strip for heater and power supply cable and additional device |
| 7 Reserve cable bushing | 14 Terminal strip for lights and fan |
| | 15 Terminal strip for power booster |
| | 16 Connection area for 230 V / 400 V |
| | 17 Earth rail |

Observe the following points when connecting the power to the sauna control unit:

- Installation may only be performed by a qualified electrician or similarly qualified person.



Please observe that in the event of a guarantee claim, a copy of the bill from the electrician performing the work must be presented.

- Work on the sauna control unit may only be performed when the power has been disconnected.
- There must be a fixed connection for the electrical power supply.
- An all-pole disconnecting device with full cut-off compliant with overvoltage category III must be fitted on-site.
- Observe the connection diagram (**Fig. 5**) on page **23**.

5.1. Connecting the power supply cable and heater cable

1. Guide the power supply and heater cable through the cable bushings **10** and **9** into the connection area for 230 V/400 V **16**.
2. Connect the power supply cables to the terminal strip **13** in accordance with the connection diagram. Observe the operating instructions for the respective devices.

5.2. Connecting the operating unit

1. Guide the connection cable for the operating unit through the cable bushing **5** into the low-voltage connection area **1**.
2. Connect the plug of the RJ-12 cable to the connection socket **3**.

5.3. Connecting the light

1. Guide the light cable through the cable bushing **12** into the connection area for 230 V/400 V **16**.
2. Connect the light cable to the terminal strip **14** in accordance with the connection diagram. Observe the operating instructions for the respective device.

5.4. Connecting the fan (optional)

1. Guide the fan cable through the cable bushing [12] into the connection area for 230 V/400 V [16].
2. Connect the fan cable to the terminal strip [14] in accordance with the connection diagram. Observe the operating instructions for the respective device.

5.5. Connecting the additional output (optional)

The additional output can, for example, be used for an infrared lamp or infrared heat plates.



WARNING!

Risk of fire

The additional output does not feature an excess temperature fuse. For this reason, only intrinsically safe devices should be operated using the additional output.

- If infrared lamps are connected to the additional output, these must have an excess temperature fuse.
- If infrared heat plates are connected to an additional output, the foil sensor P-ISX-FF must be used, and must be activated when first starting operation (see **8.5. Activating/deactivating the foil sensor** on page 26).

EN

1. Guide the connection cable for the additional device through the cable bushing [8] into the connection area for 230 V/400 V [16].
2. Connect the power supply cables to the terminal strip [13] in accordance with the connection diagram. Observe the operating instructions and safety instructions for the respective device.

5.6. Connecting the power booster (optional)

1. Guide the cable for the power booster through the cable bushing [11] into the connection area for 230 V/400 V [16].
2. Connect the cable for the power booster to the terminal strip [15] in accordance with the connection diagram. To do so, use terminal “**ST1**” for the safety circuit, and terminal “**ST2**” for the control circuit. Observe the operating instructions for the respective device.

5.7. Connecting heater sensor F1

1. Guide the wires for the heater sensor through the cable bushing **6** into the low-voltage connection area **1**.
2. Connect the red wires for the heater sensor to the terminals labelled “**STB**” in terminal strip **2**.
3. Connect the white wires for the heater sensor to the terminals labelled “**F1**” in terminal strip **2**.

5.8. Connecting bench sensor F2

1. Guide the wires for the bench sensor through the cable bushing **5** into the low-voltage connection area **1**.
2. Connect the wires for the bench sensor to the terminals labelled “**F2**” in terminal strip **2**.

5.9. Connecting the foil sensor (optional)

1. Guide the wires for the sensor through the cable bushing **5** into the low-voltage connection area **1**.
2. Connect the wires for the sensor to the terminals labelled “**FF**” in terminal strip **2**.

5.10. Status output

Any electrical device can be connected to the status output terminal which is suitable for 24 V DC voltage and draws a current no greater than 200 mA.

Make sure the polarity is correct when connecting a device. When LEDs are used, a suitable series resistor must be used.

5.11. Finishing installation

1. Connect the earth conductor for the power supply cable and all devices to the earth rail **17**.
2. Place the cover of the housing on the upper edge of the junction box.
3. Push the clip locks inwards lightly, and turn the cover of the housing downwards until it engages audibly.

6. Performing tests

The following tests must be performed by a certified electrical fitter.



WARNING!

The following tests must be performed with the power supply switched on. There is a danger of electric shock.

- NEVER touch live parts.

1. Check the contact of the earth conductors on the earth conductor terminal.
2. Check the excess temperature fuse on the heater sensor F1.
 - a. Open the heater sensor and disconnect one of the two red wires for the heater sensor.
 - b. Switch on the power unit and activate the operating unit.
 - ▶ A recurring warning tone is emitted.
 - ▶ The LEDs on the LED wheel flash. 2 LEDs flash in the power level display.
 - ▶ The control unit switches off the heater.
 - c. Switch off the power unit.
 - d. Reconnect the red wire for the heater sensor.
 - e. Now disconnect one of the white wires for the heater sensor.
 - f. Switch on the power unit and activate the operating unit.
 - ▶ A recurring warning tone is emitted.
 - ▶ The LEDs on the LED wheel flash. 4 LEDs flash in the power level display.
 - ▶ The control unit switches off the heater.
 - g. Switch off the power unit.
 - h. Reconnect the white wire for the heater sensor.
3. Check the phase circuit for sauna mode L1, L2, L3 is connected to U, V, W.

1. Ensure the phase circuit for L3 is connected to W1 when the device connected to the additional output is activated.
2. Check the maximum permissible heating output of 3.5 kW per phase on the sauna control unit.
3. When there is an optional power booster:
 - a. Check the control wires ST1, ST2 and ST3.
 - b. Check the maximum permissible heating output of 3 kW per phase on the power booster S2-18.
 - c. Check the maximum permissible heating output of 7 kW per phase on the power booster S2-30.

7. Connection diagram

Fig. 5 Connection diagram

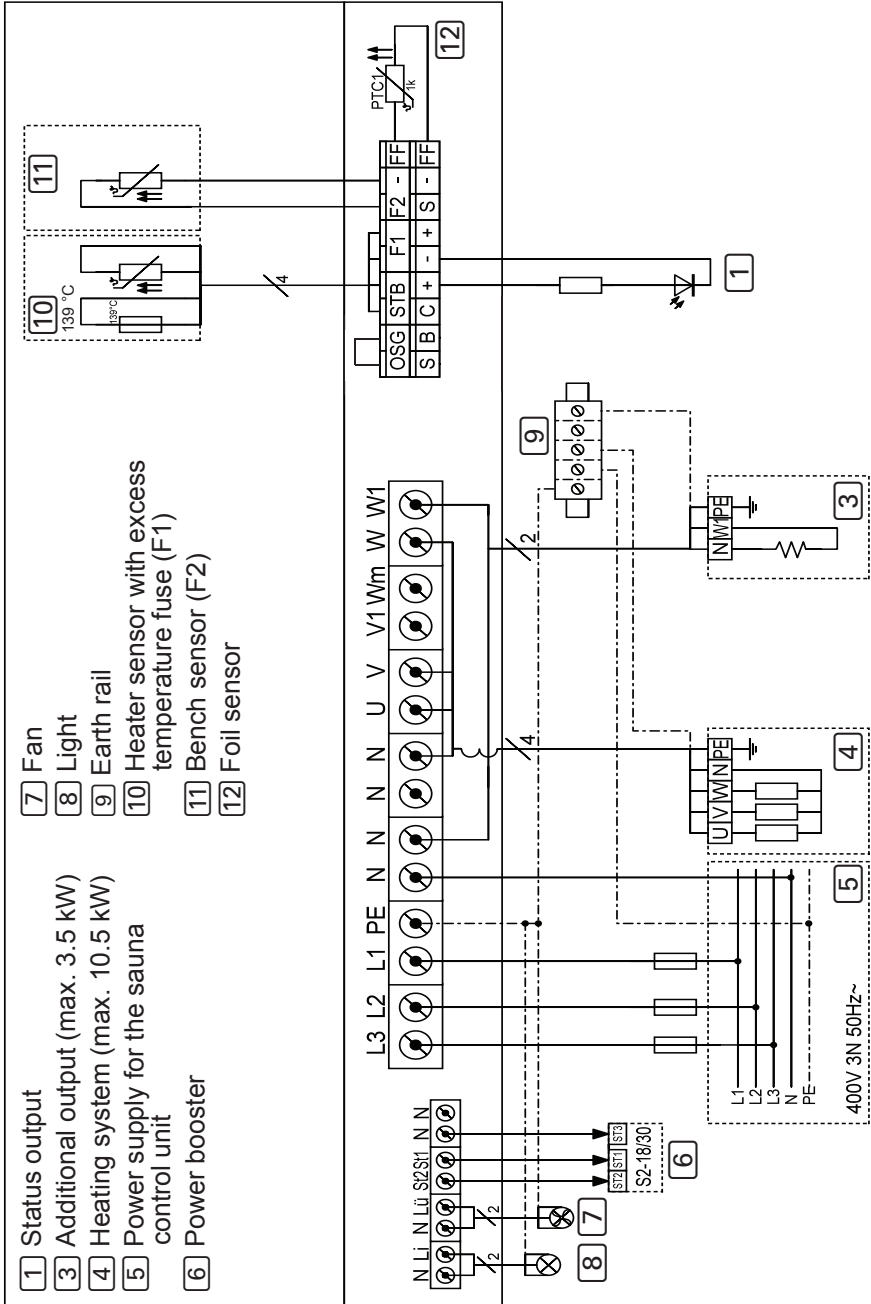

8. Starting up

The function selection switch in the low-voltage connection area allows a variety of product functions to be activated. The figure at the right shows the standard setting for the function selection switch.

Note that the control unit needs to be switched off for 10 seconds after making changes so that the settings are saved.

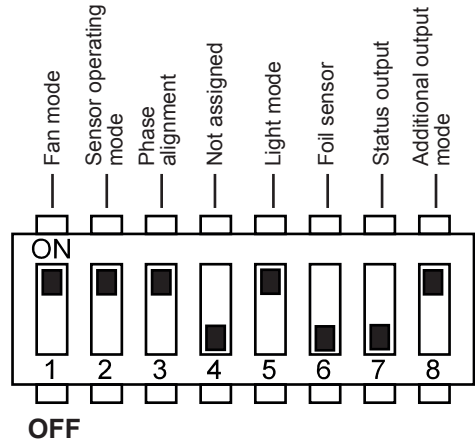

Fig. 6 Function selection switch – Standard setting

8.1. Setting the fan operating mode

The fan can either be dimmed or switched on and off. The dimmer switch function is activated or deactivated using the function selection switch **1**.

- The function selection switch **1** is set to the ON position as standard. This activates the dimmer function.
- If you wish to deactivate the fan dimmer switch, place the function selection switch **1** in the OFF position.

8.2. Activating single-sensor mode

In single-sensor mode, the sauna control unit is operated with the heater sensor with an excess temperature fuse (F1) only. The single-sensor mode must be activated above the function selection switch **2**.

- The function selection switch **2** is set to the ON position as standard. This activates two-sensor mode.
- If you wish to deactivate single-sensor mode, place the function selection switch **2** in the OFF position.

8.3. Activating/deactivating phase alignment

Phase alignment is activated or deactivated using the function selection switch **3**.

- The function selection switch **3** is set to the ON position as standard. This activates phase alignment.
- If you wish to deactivate phase alignment, place the function selection switch **3** in the OFF position.

8.4. Setting the light operating mode

The light for the sauna room can either be dimmed or switched on and off. The dimmer switch function is activated or deactivated using the function selection switch **5**.

- The function selection switch **5** is set to the ON position as standard. This activates the dimmer function.
- If you wish to deactivate the dimmer function for the sauna room light, place the function selection switch **5** in the OFF position.

8.5. Activating/deactivating the foil sensor

If an infrared heat plate is connected to an additional output, a foil sensor must be used. The foil sensor must be activated with the aid of the function selection switch **6**.

- The function selection switch **6** is set to the OFF position as standard. This activates the foil sensor.
- If you wish to activate the foil sensor, place the function selection switch **6** in the ON position.

8.6. Status output

The remote start function is activated or deactivated using the function selection switch **7**.

- The function selection switch **7** is set to the OFF position as standard. This activates two-sensor mode.
- If you wish to activate the foil sensor, place the function selection switch **7** in the OFF position.

8.7. Setting the operating mode for the additional output

The additional output can either be dimmed or switched on and off. The dimmer switch function is activated or deactivated using the function selection switch **8**.

- The function selection switch **8** is set to the ON position as standard. This activates the dimmer function.
- If you wish to deactivate the dimmer switch for the additional output, place the function selection switch **8** in the OFF position.

9. Operating elements

9.1. On the power unit



9.2. On the operating unit

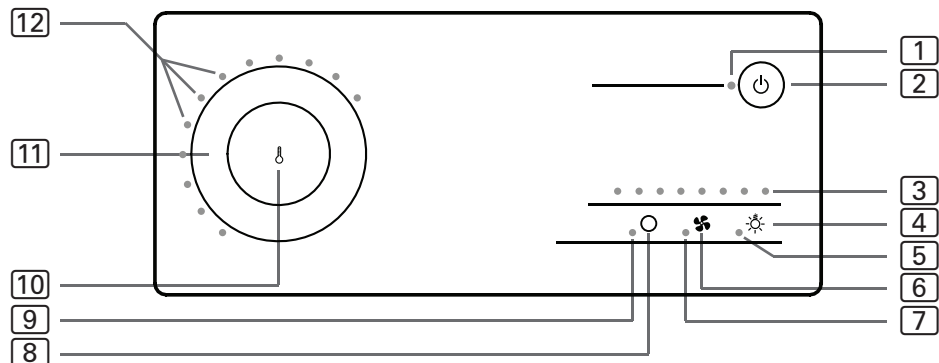

- | | |
|------------------------------|------------------------------------|
| 1 Operation LED | 7 Fan LED |
| 2 ON/OFF button | 8 Additional devices symbol |
| 3 Power level display | 9 Additional devices LED |
| 4 Light symbol | 10 Temperature symbol |
| 5 Light LED | 11 Touch wheel |
| 6 Fan symbol | 12 LED wheel |

EN

9.3. The touch wheel

The touch wheel **[11]** can be used to set preset values for the sauna room temperature and for humidity.

- If you wish to increase the preset value, swipe your finger clockwise over the touch wheel.
- If you wish to decrease the preset value, swipe your finger anti-clockwise over the touch wheel.

The preset values which you have set are indicated by the number of LEDs which light up on the LED wheel **[12]**.

In two-sensor mode (with bench sensor, F2), in addition to the preset values, values measured in the sauna room (actual values) are displayed. Different colours are used to distinguish preset and actual values:

	<i>JUST-105D-FI</i> (black operating unit)	<i>JUST-105W-FI</i> (white operating unit)
Preset values	white	red
Actual values	blue	blue

9.4. Touch wheel scaling

The preset temperature can be set to be between 55 °C and 110 °C.

The preset or actual temperatures are indicated by the number of LEDs which light up on the temperature LED wheel **[12]**. The more LEDs light up, the higher the temperature is. An additional LED is equivalent to an increase in temperature of 5 °C.

After setting the preset temperature, this LED remains active. This LED goes out when the preset temperature has been reached (exception: single-sensor mode).

<i>Number of LEDs lit</i>	<i>Temperature °C</i>
1	≤ 55
2	60
3	65
4	70
5	75
6	80
7	85
8	90
9	95
10	100
11	105
12	110



9.5. Power level display

If the dimmer switch function is activated for the device (see **8. Starting up**), you can adjust the power of the light and the fan from power level 1 to power level 8. The power of the additional device can be adjusted from power level 1 to power level 7.

The power level selected is indicated by the number of LEDs which light up in the power level display .

Power level 1 has the lowest power level and is indicated by the one LED which lights up in the power level display .

Power level 7 or 8 is equivalent to the highest power level and is indicated by the 7 or 8 LEDs that light up in power level display .

In addition, the power level display  is used for displaying errors. The number of LEDs that flash in the power level display  in the event of an error indicate the error number.

10. Operation

10.1. Switching on the light on the power unit (cleaning lights)

The light in the sauna room can be switched on and off at the power unit independently of the ON/OFF switch **A**.

- To switch the light on or off on the power unit, press the light switch **B**.



If the light switch **B** is switched on, the sauna room light will operate at full power. If you wish to dim the light above the operating unit, switch off the light switch **B**.

10.2. Switching on the power unit



WARNING!
Risk of fire

Flammable objects that are placed on the sauna heater could ignite and cause fires.

- NEVER place flammable objects on the sauna heater.
- Make sure that NO flammable objects have been placed on the sauna heater before the sauna control unit is switched on.

In order to be able to use the operating unit, the power unit must be switched on.

- Press the ON/OFF button **A** to switch the power unit on.
 - ▶ The operating unit is in standby mode.
 - ▶ The operation LED **1** on the operating unit lights up in red.

10.3. Activating the operating unit

- Press the ON/OFF button **2** for one second.
 - ▶ The operating unit is activated.
 - ▶ The operation LED **1** lights up in blue.

10.4. Starting the sauna

1. Press the temperature symbol **[10]** in the middle of the touch wheel **[11]**.
 - ▶ The sauna heater switches on.
2. Use the touch wheel **[11]** to set the preferred temperature.
 - ▶ The LED wheel **[12]** shows the preset temperature for a few seconds.
 - ▶ In two-sensor mode, the LED wheel **[12]** then shows the actual temperature. In single-sensor mode, it continues showing the preset temperature.

10.5. Switching off the sauna

- Press the temperature symbol **[10]** in the middle of the temperature touch wheel **[12]**.
 - ▶ The sauna heater switches off.
 - ▶ The temperature LED wheel **[12]** goes out.

10.6. Switching on the additional output

Infrared lamps, or infrared heat plates, for example, can be connected to the additional output on the sauna control unit.



WARNING!

Risk of fire

Flammable objects that are placed on or in front of the infrared lamp could ignite and cause fires.

- NEVER place flammable objects on or in front of the infrared lamp.
- Make sure that NO flammable objects have been placed on or in front of the infrared lamp before you switch it on.

When the dimmer switch function is activated

When the dimmer switch function for the additional output is activated, the power for the additional device can be set to any level between level 1 to level 7.

1. Press the additional device symbol **[8]**.
 - ▶ The additional device LED **[9]** lights up.
 - ▶ The set power level is displayed for one second in the power level display **[3]**.
2. Press (press and hold) the additional device symbol **[8]** and hold it down for several seconds.
 - ▶ While pressing and holding the symbol, the power level is increased by an increment of one every second. Once power level 7 has been reached, it starts again at power level 1.
3. Once the preferred power level has been reached, let go of the button.
 - ▶ The additional device will operate at the power level selected.
 - ▶ After a number of seconds, the power level display **[3]** goes out.

When the dimmer switch function is deactivated

When the dimmer switch function for the additional output has been deactivated, you can only switch the additional device on and off. The device will always operate at full power.

- Press the additional device symbol **[8]**.
 - ▶ The additional device LED **[9]** lights up.
 - ▶ The additional device switches on.





10.7. Switching off the additional device

- Press the additional device symbol **[8]**.
 - ▶ The additional device switches off.
 - ▶ The additional device LED **[9]** goes out.

10.8. Switching on the light



When the dimmer switch function is activated

When the dimmer function for the light is activated, the power for the light can be set to any level between level 1 to level 8.



1. Press the light symbol 
 - ▶ The light LED  lights up.
 - ▶ The set power level is displayed for one second in the power level display .
2. Press (press and hold) the light symbol  and hold it down for several seconds.
 - ▶ While pressing and holding the symbol, the power level is increased by an increment of one every second. Once power level 8 has been reached, it starts again at power level 1.
3. Once the preferred power level has been reached, let go of the button.
 - ▶ The light will operate at the power level selected.
 - ▶ After a number of seconds, the power level display  goes out.

When the dimmer switch function is deactivated

When the dimmer function for the light has been deactivated, you can only switch the light on and off. The device will always operate at full power.

- Press the light symbol 
 - ▶ The light LED  lights up.
 - ▶ The light switches on.

10.9. Switching off the light

- Press the light symbol 
 - ▶ The light switches off.
 - ▶ The light LED  goes out.







The status of the light function is saved automatically. If the control unit is switched off using the operating unit when the light is on, then the sauna control unit saves this status and restores it the next time the unit is switched on.

10.10. Switching on the fan



When the dimmer switch function is activated

When the dimmer switch function for the fan is activated, the power for the fan can be set to any level between level 1 to level 8.



1. Press the fan symbol 
 - ▶ The fan LED  lights up.
 - ▶ The set power level is displayed for one second in the power level display .
2. Press (press and hold) the fan symbol  and hold it down for several seconds.
 - ▶ While pressing and holding the symbol, the power level is increased by an increment of one every second. Once power level 8 has been reached, it starts again at power level 1.
3. Once the preferred power level has been reached, let go of the button.
 - ▶ The fan will operate at the power level selected.
 - ▶ After a number of seconds, the power level display  goes out.

When the dimmer switch function is deactivated

When the dimmer switch function for the fan has been deactivated, you can only switch the fan on and off. The device will always operate at full power.

- Press the fan symbol 
 - ▶ The fan LED  lights up.
 - ▶ The fan switches on.

10.11. Switching off the fan

- Press the fan symbol 
 - ▶ The fan switches off.
 - ▶ The fan LED  goes out.



The status of the fan function is saved automatically. If the control unit is switched off using the operating unit when the fan is on, then the sauna control unit saves this status and restores it the next time the unit is switched on.

10.12. Deactivating the operating unit

- Press the ON/OFF button **2** for one second.
 - ▶ LEDs **5**, **7** and **9** and the LED wheel **12** goes out.
 - ▶ The operation LED **1** lights up in red.
 - ▶ The operating unit is in standby mode.

10.13. Switching off the power unit

If you will not be using the sauna control unit for an extended period of time, switch the sauna control unit off at the power unit.

- Press the ON/OFF button **A**.
 - ▶ The operation LED **1** goes out.
 - ▶ The sauna control unit is switched off.

11. Cleaning and maintenance

11.1. Cleaning

ATTENTION!***Damage to the unit***

The sauna control unit is protected against jets of water, however direct contact with water could still damage the unit.

- NEVER immerse the device in water.
 - Never pour water over the device.
 - Never clean the device with a cloth that is too wet.
-

1. Immerse a cleaning cloth in a mild, soapy solution.
2. Wring the cleaning cloth out well.
3. Wipe the power unit and the front of the operating unit carefully.

11.2. Maintenance

The sauna control unit is maintenance-free.

12. Disposal



- Dispose of packaging materials in accordance with the applicable disposal regulations.
- Used devices contain reusable materials, as well as hazardous substances. Do not dispose of your used device with household waste, but do so in accordance with the locally applicable regulations.

13. Troubleshooting

Error messages

The sauna control unit is equipped with diagnostic software which monitors system statuses at start-up and during operation. As soon as the diagnostic software identifies an error, the sauna control unit switches the sauna heater off.

Errors are indicated by a recurring warning tone emitted by the power unit and by the flashing lights on the LED wheel [12] on the operating unit. Furthermore, the error number is displayed with the help of the power level display [3]. The number of LEDs on it which are flashing indicates the error number. The following table describes the errors which may occur, and their causes. If necessary, tell the error number to your customer service specialist.

Switch the sauna control unit off on the power unit using the ON/OFF switch **A** and rectify the error before switching the sauna control unit on again.

<i>Error</i>	<i>Description</i>	<i>Cause / rectification</i>
01	Safety shut-off	The safety shut-off function is deactivated on this sauna control unit. A wire jumper has been connected to the "OSG" terminal in the factory. Inspect this jumper, if necessary.
02	Excess temperature fuse	The maximum temperature of 139 °C above the heater has been exceeded.
03	Communication error	No power unit has been connected, or the contact is poor.
04	Heater sensor error	Defective heater sensor, poor contact, or short circuit.
05	Foil sensor error	Defective foil sensor, poor contact or short circuit.
06	Bench sensor error	Defective bench sensor, poor contact or short circuit.
08	Foil sensor excess temperature	The maximum foil temperature of 100 °C was exceeded.

14. Fuses

Fuses for light, fan/power expansion and electronics as well as a spare fuse are located in the sauna control unit's connection area.

These are 1A time delay micro fuses and can be ordered using the PRO-FUSE item number.

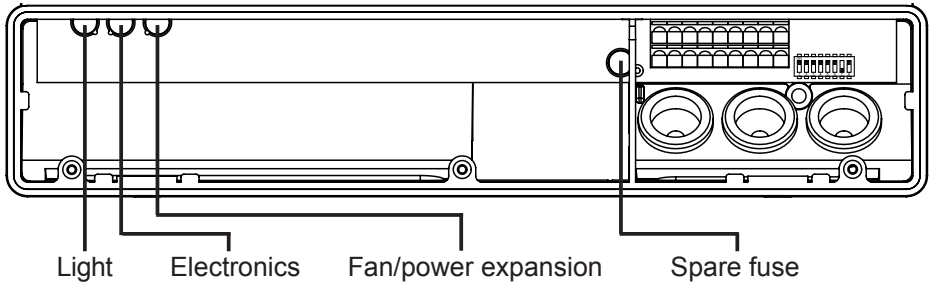

In order to replace the fuse, pull the fuse link straight out and insert the new fuse.

15. Technical data

Ambient conditions

Storage temperature:	-25 °C to +70 °C
Ambient temperature:	-10 °C to +40 °C
Relative humidity:	max. 95%

Dimensions

Installation cut-out:	213 x 82 mm
Power unit	307 x 175 x 52 mm
Operating unit (with installation frame)	222 x 94 x 38 mm
Operating unit (without installation frame)	222 x 94 x 31 mm
Glass panel for the operating unit	3.5 mm

Sauna control unit

Switched voltage/three-phase 3N:	400 V AC
Frequency:	50 Hz
Contact rating/heater:	3 x 3.5 kW
Switched current per phase/heater:	16 A
Contact rating/additional output (dimnable)*	500 W
Contact rating/additional output (switchable)*	3.5 W
Switched current/additional output:	16 A
Status output:	24 V/200 mA
Rated voltage:	230 V
Protection type (protected against jets of water):	IPX4
Connection to the mains supply as fixed wiring (fixed connection)	

* The additional output does not feature an excess temperature fuse. For this reason, only intrinsically safe devices should be operated using the additional output.

EN

Light

Contact rating:	100 W
Fuse:	1A T

Fan

Contact rating:	100 W
Fuse:	1A T

Setting ranges

Temperature:	55 °C to 110 °C
--------------	-----------------

Thermal safety

Heater sensor with excess temperature fuse (139 °C shut-off temperature)

Automatic heating time limitation 6 h*

Single-sensor mode or two-sensor mode for selection

Connection cables

Power supply cable:	min. 5 x 2.5 mm ²
Heater supply cable (temperature-resistant up to 150 °C):	min 2.5 mm ²
Sensor wires (temperature-resistant up to 150 °C):	min 0.5 mm ²
Light wire:	min. 1.5 mm ²
Fan wire:	min. 1.5 mm ²

* EN 60335-2-53 specifies a heating time limitation of 6 h for saunas for private use.